

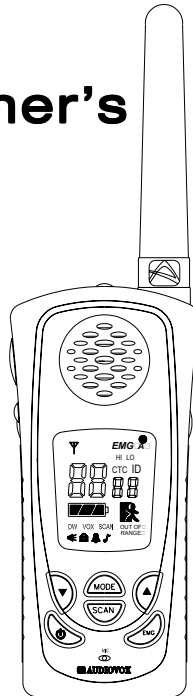

General Mobile Radio Service (GMRS) Model: GMRS-7000

Owner's Manual



For Customer Service
Visit Our Website At
www.audiovox.com
Product Information, Photos,
FAQ's, Owner's Manuals

© 2002 Audiovox Electronics Corp., Hauppauge, NY 11788

Customer Service
1-800-290-6650

Released: 3-28-02.

CAUTION

ONLY USE THE AUDIOVOX-APPROVED RECHARGER WHEN RECHARGING THE NICKEL METAL HYDRIDE (NiMH) BATTERY PACK. USE ONLY THE AUDIOVOX RECHARGEABLE BATTERY PACK APPROVED FOR THIS UNIT. DO NOT USE THE AUDIOVOX CHARGER WITH OTHER BRANDS OF BATTERIES.

AVOID PLACING THE GMRS-7000 RADIO TRANSCEIVER FOR PROLONGED PERIODS OF TIME IN DIRECT SUNLIGHT OR TEMPERATURES BELOW -4° F (-20° C) OR ABOVE 140° F (60° C).

KEEP THE ANTENNA AT 1 INCH (2.5 cm) AWAY FROM YOUR HEAD AND BODY. DO NOT USE YOUR GMRS-7000 RADIO TRANSCEIVER WITH A DAMAGED ANTENNA. PLACE THE RUBBER COVER ON JACKS WHEN NOT IN USE.

GMRS LICENSE:

USE OF THIS RADIO WITHIN THE UNITED STATES REQUIRES AN FCC GMRS LICENSE. AN INDIVIDUAL 18 YEARS OF AGE OR OLDER, WHO IS NOT A REPRESENTATIVE OF A FOREIGN GOVERNMENT, IS ELIGIBLE TO APPLY FOR A GMRS SYSTEM LICENSE. YOU WILL NEED TWO FORMS FROM THE FCC; FCC FORM 159 AND FCC FORM 605 MAIN FORM AND SCHEDULE F. YOU CAN FIND THE FORMS ONLINE AT: [HTTP://WWW.FCC.GOV/FORMPAGE.HTML](http://www.fcc.gov/formpage.html), OR CALL 1-800-418-3676.

POWER SETTING (Refer to Page 12.)

Your GMRS-7000 can operate at two power levels: High (2W) and Low (0.5W). You will find that for the majority of your needs, the low-power setting will provide adequate communications and there should seldom be any need to use high power, except in situations where you need absolute maximum range. Using low power will greatly extend battery life. We suggest you experiment with switching between low and high power. However, we do recommend that you **not change** this setting unless it proves to be necessary in your particular situation.

Model GMRS-7000 (FCC License Required)

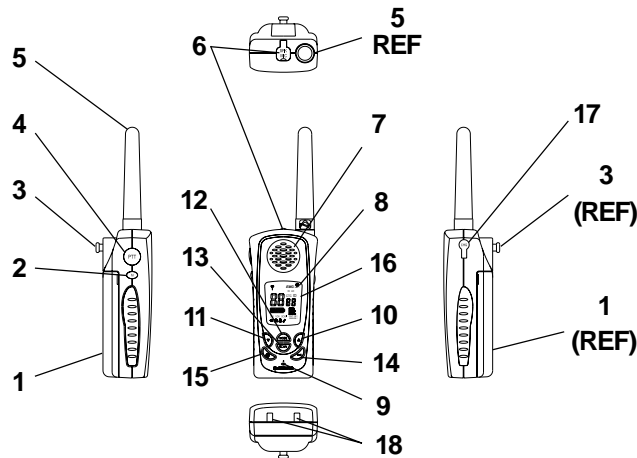

- | | |
|--|--|
| 1. Battery Pack | 12. MODE Button |
| 2. Monitor (M)/Backlight Button | 13. SCAN /Lock Button |
| 3. Carry Clip Stud | 14. Emergency (EMG) Call Button |
| 4. Push-To-Talk (PTT) Button | 15. Power On/Off Control |
| 5. Antenna | 16. Combination Transmit Indicator (Red)/Receive and Monitor Indicator (Green) |
| 6. External Speaker(SPK)/Microphone (MIC) Jack | 17. Battery Pack Charging Jack (CHG) |
| 7. Built-in Speaker | 18. Battery Pack Charging Contacts |
| 8. Liquid Crystal Display (LCD) | |
| 9. Built-in Microphone | |
| 10. Up Channel/Volume Button | |
| 11. Down Channel/Volume Button | |

Model GMRS-7000 DISPLAY

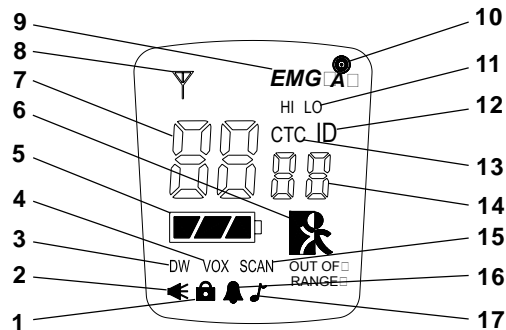

- 1. Key Lock Indicator:** Icon appears when the keypad is locked. This function disables keys such as channel up/down and MODE.
- 2. Monitor Indicator:** Icon appears when the Monitor (M) button is pressed and the channel monitor function is activated.
- 3. Dual Watch Mode Indicator:** Indicator appears when dual watch mode is active.
- 4. Voice Activated Transmission (VOX) Indicator:** This function allows hands free conversation. The indicator appears when the VOX mode is activated.
- 5. Battery Level Indicator:** Icon indicates the battery charge level.
- 6. Out of Range Indicator:** Icon will be on steady when received signal strength is normal; icon flashes when signal strength becomes weak and intermittent.
- 7. Large Segment Display:** Indicates the channel number in use.
- 8. Signal Strength Indicator:** Icon appears when a signal is being received. The icon consists of five bars to indicate the received signal level.
- 9. Emergency Indicator: EMG** Icon appears when the EMG button is pressed. (The frequency is **NOT** monitored by authorities).

- 10. Weather Mode Indicator:** Icon will be on steady when in the weather band mode. The icon will blink when in the GMRS mode with the alert active.
- 11. HI/LO Indicators:** Appropriate icon appears when the transmit power is set to desired output power.
- 12. Caller Identification (ID) Indicator:** This indication appears when you select a caller identification code (between 1 and 10). ID selection operates in conjunction with the small segment display, and can also be used to identify a calling party in the monitor mode.
- 13. Coded Tone Controlled Squelch System (CTC) Indicator:** Indicator appears when the CTCSS tone function is active.
- 14. Small Segment Display:** Displays the CTCSS tone option in the channel from (00-38).
- 15. Scan Indicator:** This function allows the user to scan a channel and/or a tone code every .5 second to search for a valid signal.
- 16. Beep Tone Indicator:** Icon appears when beep button confirmation tone is selected; icon disappears when tone is off.
- 17. Roger Beep Tone On/Off Indicator:** This icon appears when the Roger Beep tone is on, and disappears when tone is not in use.

Powering the transceiver:

Your GMRS-7000 radio transceiver operates on an NiMH rechargeable battery pack. Only Audiovox-approved rechargeable batteries can be recharged in the radio transceiver using the charging Adapter supplied with the unit. This will ensure optimum performance for the GMRS-7000. Use of the Audiovox Adapter with other brands of batteries is not recommended.

Batteries

The GMRS-7000 is powered by:

Audiovox Rechargeable NiMH Battery Pack - (Rechargeable NiMH battery pack and Charging Adapter included). Use only the Audiovox-approved rechargeable battery pack and charger when charging the battery pack internal to the unit.

NOTE: To extend battery life, avoid overcharging the battery pack.

Installing the battery pack:

Battery pack installation is made more convenient when the carry clip is removed. To do this, press down on the spring latch securing the clip to radio and slide the clip downward and away from the mounting stud. Next, at the battery pack retaining clip, press up with the thumb to release the top of the battery pack and lift off the entire pack assembly.

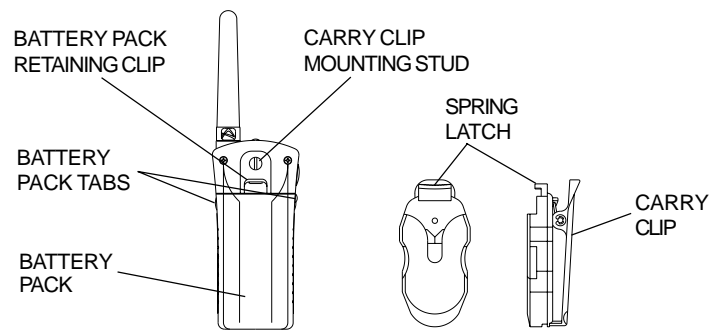

1. Using thumb, press up on battery retaining clip to release top of battery pack.
2. While holding retaining clip up, grasp battery pack tabs with other hand and lift battery pack up and off unit.
3. Insert bottom of battery pack into bottom of compartment; then press top into place until retaining clip clicks into locked position. Replace carry clip onto mounting stud.

To improve performance and provide longer operating times for the GMRS-7000:

If the unit is not to be used for an extended period of time, remove the battery pack. An old or leaking battery pack can cause damage to the unit and will void the warranty.

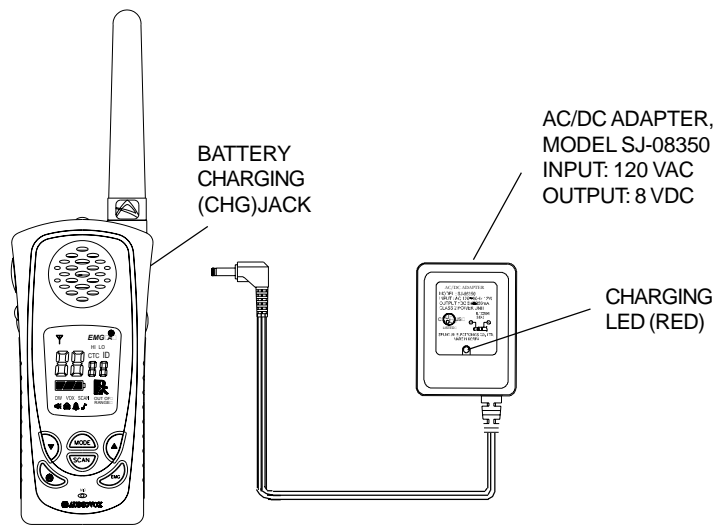

GMRS-7000 OPERATIONAL MODES

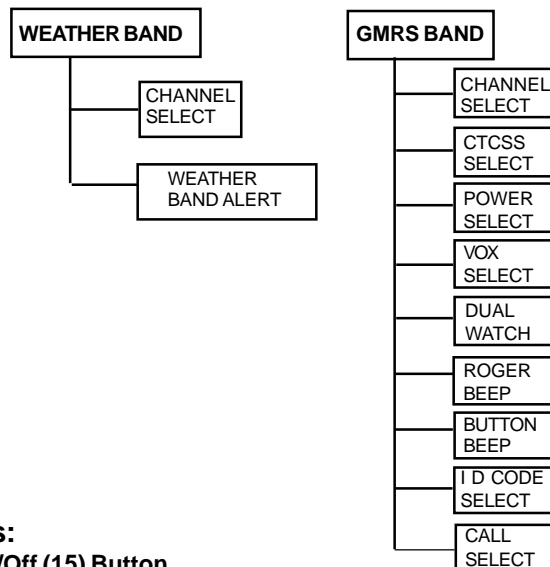



Controls:

Power On/Off (15) Button

Press and hold the power on/off button () for at least 2 seconds. You will hear a confirming melody to indicate the unit is on. To turn the unit off, press and hold the button for at least 2 seconds.

Monitor/Display Backlight Button (2)

This button is used to check activity on the current frequency before transmitting. Check activity by pressing the Monitor (M) Button longer than 2 seconds; the  icon will appear on the display and you will hear static if frequency is clear. ***Do not transmit if you hear conversation.***

Hold down the Monitor Button again longer than 2 seconds and the  icon will disappear from the display.

The monitor function will temporarily bypass the squelch setting and play all signals on a given channel. This feature is useful when communicating with other parties at extreme range.

By pressing the monitor button momentarily, the LCD backlight is turned on accompanied by a beep tone; the LCD backlight will turn off automatically in about 5 seconds, or when the monitor button is pressed momentarily once again.

Push To Talk (PTT) Button (4)

Pressing and holding this button will allow you to speak to any transceiver that is set to the same channel and privacy code setting as yours. Hold the transceiver approximately 1 to 2 inches from your face as you speak into the built in microphone (9). After you have finished speaking, release the PTT Button to allow reception of incoming signals. It is not possible to transmit and receive at the same time. The Transmit/Monitor LED (16) on the right side of the LCD Panel (8) will light **red** while the PTT Button is pressed.

Releasing the button allows the unit to revert to standby mode. When receiving an incoming signal, the Transmit/Monitor LED indicator will light **green** and the received signal strength indicator () will display the relative strength of the signal.

The PTT Button can also be used as a two-way call ringer. Pressing the button twice quickly will call another party on the same channel. The Transmit LED will light **red** for approximately 3 seconds and then go out.

Up Channel/Volume Button (10)

In the standby mode, pressing this button will increment the listening volume. When in function edit mode this button will be used to adjust the unit's settings. The display will indicate the current volume level between 1 and 7 by the small number in the icon ().

Down Channel/Volume Button (11)

In the standby mode, pressing this button will decrement the listening volume. When in function edit mode this button will be used to adjust the unit's settings. The display will indicate the current volume level between 1 and 7 by the small number in the icon ().

Mode Button (12)

This button is used to select the various GMRS and weather band feature settings such as channel/CTCSS code selection, VOX mode, etc.

Emergency (EMG) Call Button (14)

This radio has a quick access button (EMG) to the Emergency and Assistance Channel. This channel is **NOT** monitored by local authorities. When using this channel, **EMG** appears on the display. Pressing this button will set the transceiver to channel 10, operating on 462.6750 MHz.

External Speaker (SPK)/Microphone (MIC) Jack (6)

This jack accepts an optional Audiovox headset/microphone connector. For additional optional equipment and accessories for the GMRS-7000 visit the Audiovox web site at www.audiovox.com.

Scan/Lock Button (13)

Press this Button momentarily to enable or disable the scan mode. Press and hold Button for more than 1 second to lock or unlock the key pad, except Power, PTT, Monitor (M), EMG, and Volume Up/Down. When the keypad is locked, the () icon will display in the bottom left corner.

Operating Modes and Features**GRMS Operation:**

- From GMRS standby mode, press and hold the () button for 2 seconds to turn on power.
- Press the MODE button so the Channel number flashes.

- Select the desired channel with the Up (10) and Down (11) Buttons. When receiving a call, the signal strength meter appears to indicate incoming received signal strength and the Monitor section of the Transmit/Monitor LED (16) lights **green**.
- Press and hold the PTT button (4) to transmit, then speak into the microphone clearly and slowly. The Transmit section of the Transmit/Monitor LED (16) lights **red**.
- Release PTT Button (4) to receive.
- Communication can only be accomplished when the channel and CTCSS tone frequency of at least two parties are the same.
- The **CTC** icon will be displayed on the LCD panel if the CTCSS tone frequency function is enabled.

Channel Selection

In order to communicate with other GMRS units, both transmitting and receiving party must be on the same frequency.

The GMRS-7000 has 15 channels (frequencies) (1-15) indicated by the large digits on the LCD display panel. Channels 1 through 7 are the same frequency as FRS channels 1 through 7. Communication with Audiovox FRS and compatible units is possible on these seven channels. Before transmitting on the selected channel, press the Monitor (M) Button (2) to check the activity on that channel. If there is activity on the selected channel, change to another channel that is clear.

To change the channel:

- From GMRS standby mode, press the MODE button once so the channel number flashes.
- Press the Up Button (10) briefly to move to the next higher main channel number.
- Press the Down Button (11) briefly to move to the next lower main channel number.

CTCSS Mode (Sub-Channel) Selection

The Coded Tone Controlled Squelch System (CTCSS) provides 38 Sub-Frequencies. This feature allows you to utilize the coded squelch tones (01–38) within a main channel to communicate with another party on the same main channel using the same subcode. (This filters out unwanted transmissions without the same coded squelch tone). There are 38 CTCSS Sub-channels for each main channel. A different subcode may be selected for each of the 15 channels.

To change the CTCSS Sub-channel:

- From GMRS standby mode, press the MODE Button twice; a flashing **oF** or sub-channel number is displayed, together with the flashing **CTC** icon. If **oF** is displayed, press the Up or Down button to enable the CTCSS mode; the **CTC** icon will also flash on the display with the flashing sub-channel number.
- Then press the Up or Down button to select the desired sub-channel for use.
- Press the PTT button momentarily to confirm selection.

The CTCSS mode can be turned off by selecting the **oF** icon as the setting.

NOTE: To communicate with other GMRS units, they must be switched to the same channel and CTCSS subcode. To communicate with other GMRS units that do not have subcodes, switch your unit to the same channel with the subcode set to **oF**.

The CTCSS subcodes do not prevent others from hearing your transmission. This will only allow you to ignore all traffic on a given channel not using the same subcode.

Transmit Power Selection Mode

This feature permits selection of the transmitting power level to high or low. Using low power, the unit will have a lower transmit range but battery life will be increased. (Refer to page 2 for Power Setting notes.)

To access the transmitter power selection function:

- From GMRS standby mode, press the MODE Button three times until the **Po** icon appears with a flashing **HI** or **Lo** indication on the display.

- Press the Up or Down button to toggle between the **HI** and **Lo** selections.
- Press the PTT button momentarily to confirm selection.

The display will indicate the current setting in GRMS standby mode.

VOX Selection Mode

This option enables you to have hands-free conversation. Your voice or nearby sound is detected and the radio transmits without the need to press the PTT button.

To set radio for VOX operation:

- From GMRS standby mode, press the MODE button four times until the **VOX** icon flashes on the display.
- Press the Up or Down button to select VOX On (if **oF** appears flashing) and the **1-5** VOX level sensitivity.
- Momentarily press the PTT button to confirm the VOX selection; the **VOX** icon will appear steady on the LCD display.

A VOX sensitivity of 5 is the most sensitive, and should be used in a relatively quiet surrounding. A VOX sensitivity of 1 is the least sensitive and should be used in a noisy surrounding.

VOX can be turned off by selecting **oF** as the setting.

Dual Watch Mode

This feature allows you to monitor two channels at the same time. While in dual watch mode, the unit will continuously monitor both the primary and dual watch channel. Received signals will be played for 5 seconds, then the unit will resume scanning the two channels. Pressing the PTT button during a received transmission will set the unit to transmit on the same channel. Pressing the PTT button when no signal is received will set the unit to transmit on the primary channel.

To set the Dual Watch Mode:

- From GMRS standby mode, press the MODE button five times; **dc** appears on the display with the flashing **DW** icon. If the dual watch mode

is off, the **oF** icon will also appear flashing.

- To enable the dual watch mode, press the Up or Down button; the dual watch channel number will flash and start to increment up or down as the Up or Down button is pressed.

NOTE: while selecting the dual watch channel, a long tone will sound when the channel selected for dual watch mode is the same as the primary channel when the key tone feature is enabled.

- Press the PTT button to confirm selection of the dual watch channel. The display will now alternate between the primary channel and the dual watch channel just selected.

Roger Beep Tone

The Roger Beep is a tone which is automatically transmitted whenever the PTT button is released. This tone alerts the receiving party that the transmission has been terminated intentionally.

To enable and disable the Roger Beep tone:

- From GMRS standby mode, press the MODE Button six times until **rb** appears on the display with the flashing Roger Beep icon (🎵) and **On** or **oF**.
- Press the Up or Down Button to select the tone on or off as desired.
- When enabled, the tone icon (🎵) appears steady on the display.
- Press the PTT button momentarily to confirm selection.

Key Tone

This feature allows the transceiver to sound a confirmation tone whenever the following keys are pressed: Monitor (M) Button, Up/Down Buttons, MODE Button, SCAN Button, or the EMG Button.

To turn the key tones on or off:

- From GMRS standby mode, press the MODE Button seven times until **bP**, the Bell (🔔) icon, and **On** or **oF** flash on the LCD display.
- Press the Up or Down Button to toggle the key tone feature On or Off.
- Press the PTT button momentarily to confirm selection.

When the key tone feature is on, the Bell icon appears steady on the display, and the beep tones sound in response to button activation.

Caller Identification (ID) Select

The caller ID function allows you to assign an ID code between 1 and 10; this code accompanies your transmission whenever you call another party, and will appear at the receiving unit, provided it has caller ID capability.

To select a caller ID code for your unit:

- From GMRS standby mode, press the MODE button eight times; **Id** appears, together with a flashing **ID** and number (or **oF**) indication.
- If **oF** appears, press the Up or Down Button to select the desired caller identification code for your unit between 1 and 10.
- Press the PTT button momentarily to confirm selection.

Now, your caller ID number will accompany each transmission, and will appear on the receiving unit, if the receiving unit is so equipped, and vice-versa.

Call Ringer Selection Mode

The transceiver provides 3 user-selectable call ringer melodies to alert you to an incoming call.

To select your favorite call ringer melody:

- From GMRS standby mode, press the MODE button nine times; **C** will appear on the display, together with a flashing number (or **oF**) between **01** and **03**, and an appropriate call ring.
- Press the Up or Down Button to preview and hear the 3 available call melodies.
- Press the PTT button momentarily to confirm selection.

Refer to the PTT button (4) can also be used to initiate a call; pressing the button twice quickly will call another party on the same channel and transmit the call ring signal at the same time.

Emergency and Assistance Channel Mode

This radio has a quick access button (EMG) to the Emergency and Assistance Channel. This channel is **NOT** monitored by local authorities.

To turn the Emergency Channel feature on or off:

- Press and release the EMG Button; **EMG** appears on the display together with a Channel 10 indication.
- When the transceiver is set to Emergency Channel 10, The transceiver transmits and receives on a special frequency (CH10: 462.6750 MHz).

The Emergency Channel can be selected quickly from any user mode.

- To exit the Emergency Channel mode, press the Emergency (EMG) Button; **EMG** and Channel **10** disappear from the display, and the radio reverts to the current user selected channel.

Channel Scan Operation

This feature allows you to monitor all channels automatically for valid signals. While scanning, you can transmit and receive. When a signal is received, the scan is interrupted and will return to scan mode 15 seconds after reception is terminated.

NOTE: While the scan function is active, the MODE button will be inoperative. The scan mode will reduce the overall battery life since the battery save function is overridden. The scan function is disabled if the radio is set to the Emergency Channel feature.

To enable the channel scan mode:

- From GMRS standby mode, momentarily press the SCAN Button; (**SCAN**) will appear on the LCD display.
- The radio will display each channel (1-15), and CTCSS subcode, if enabled, in order as the scan mode operates to find an active main channel.
- If the unit doesn't find any signals and you want to transmit, press the PTT switch to return to home channel operation. The transceiver will



automatically resume scanning approximately 15 seconds after the communication is completed.

- If there is no activity and you want to leave the scan mode, press the SCAN button momentarily and the unit will return to normal operation; the **SCAN** icon will disappear from the LCD display.

Auto Key Lock Selection Mode

This feature prevents accidental channel change to the preferred settings of the unit. The Auto Key Lock function temporarily disables the MODE and SCAN Buttons.

To access the Auto Key Lock selection menu:

- From GMRS standby mode, press and hold the Scan Button for over 2 seconds to Lock the Auto Key function; the () icon appears on the display.
- The Power, PTT, Up/Down, EMG and Monitor Buttons are not effected.
- To unlock the Auto Key function, press and hold the SCAN button for at least 2 seconds; the icon () disappears from the display.

NOTE: If the unit is turned off while Key Lock is on, the Key Lock mode will still be in effect when the unit is turned on again.

Out of Range Indication

The GMRS-7000 provides an Out-of-Range indication when reception is no longer intelligible or too weak to be discernible. When this condition occurs, the **OUT OF RANGE** message and the  icon appears on the display, reminding you that you are outside the range of the unit, or that signal reception is being obstructed by natural or man-made objects.

Weather Band Operation

Channel Selection

This feature provides access to 10 channels within the weather band (7 NOAA channels and 3 Canadian marine channels). To select a weather channel, the unit must be in the weather channel mode. Press and hold

the MODE button for at least 2 seconds; the weather alert icon () will appear, together with a channel number in the band. Press the MODE button (12) until the channel number flashes.

To change the channel:

- Press the Up Button (10) briefly to move to the next higher main channel number.
- Press the Down Button (11) briefly to move to the next lower main channel number.

Weather Alert Mode

The weather alert mode notifies the user of unusual weather situations when the radio is set to the GMRS mode.

To access the weather alert function:

- From Weather Band standby mode, press the MODE button once to access the weather channels and use the Up or Down Button to select the desired channel.
- Press the MODE button again to access the weather alert function; weather icon () and **AL On** or **oF** appear flashing on the display.
- Use the Up or Down buttons to enable (**On**)/disable (**oF**) the alert function. The weather icon will stop blinking on the display in the GMRS mode when the alert is disabled.
- Press the PTT Button to confirm your selection.
- Press and hold the MODE button for at least 2 seconds to exit the weather function.

Battery Alert

The battery icon () on the LCD display indicates the battery charge level. When the battery icon appears empty, recharge the battery or install a fresh battery pack. If the battery pack is not replaced, an audio tone will sound every 10 seconds to warn the user that the battery pack must be replaced or recharged.

NOTES FOR GOOD COMMUNICATION

1. The GMRS-7000 15 channels are shared on a 'take turns' basis. This means other groups may be talking on any of the channels. A common code of ethics/courtesy is to switch to another vacant channel and not to attempt to talk over someone who is already using the channel you first selected.
2. The GMRS-7000 has been designed to maximize performance and improve transmission range in the field. To avoid interference, it is recommended that you do not use the units closer than 5 feet apart.
3. For best transmission results, always keep your mouth about 2-3 inches from the microphone (9) and speak slowly in a normal voice.
4. To increase battery life, avoid features such as Scan and Dual Watch. These features will reduce operating time considerably.

Warning

- Do not operate the transceiver unless you are licensed to do so.
- Remove the battery from the transceiver if it is not expected to be used for long periods. This will eliminate the possibility of chemicals leaking from the battery and corroding the transceiver.
- Avoid exposing the transceiver to water or extremes of temperature.
- Do not use this device in or near a mining facility, which uses remotely triggered explosives or in areas labeled "Blasting Area". Premature or accidental detonation may result.
- Do not attempt to modify or in any way increase the output of this transceiver. Its output is designed to meet the legal limits set by the FCC.
- Do not use this device or change the battery in potentially explosive atmospheres as sparks in such areas could result in an explosion.
- Turn your transceiver off wherever posted notices restrict the use of radios or cellular telephones. Facilities such as hospitals may use equipment that is sensitive to RF energy.

- Turn your transceiver off on board aircraft when requested to do so.
- Do not place your radio in front of a vehicle's air-bag. If the air-bag deploys, it could propel the transceiver like a projectile causing bodily injury.

Troubleshooting

| Problem | Possible cause | Correction |
|--|---|--|
| No transmission while pressing the PTT Button | Weak battery pack | Charge or replace battery pack |
| Weak or no signal received | Weak battery pack | Charge or replace battery |
| | Channel and privacy code not set the same as target transceiver | Adjust the transceiver's settings to match those settings of the target transceiver |
| | Volume level too low PTT Button inadvertently depressed | Increase volume level Release PTT Button |
| | Excessive radio interference on a particular channel Obstruction of radio signal | Change to a different channel Avoid operating in or near large buildings or obstructions |
| Unit beeps, but will not function when turned on | Battery pack extremely discharged | Charge or replace battery pack |
| Reception of unwanted signals | CTCSS privacy mode not on | Turn on the CTCSS privacy mode and set code number to match the setting of the target transceiver. |
| | Interference from electronic devices such as computers or TVs | Turn the devices off or move farther away from them. |

Technical Specifications:

General

| | |
|--------------------------------|----------------------------------|
| Frequency Range | |
| GMRS (15 Channels) | 462.5500 - 462.7250 MHz |
| Channel Spacing | 12.5 kHz |
| Weather Band (7 Channels) | 162.4000 - 162.5500 MHz |
| Canadian Maritime (3 Channels) | 161.6500, 161.7750, 163.2750 MHz |
| Privacy Codes | 38 for each main channel |
| Dimensions (W x H x D) | 2.10 in x 3.86 in x 1.10 in |
| (Without Antenna) | 52 mm x 117 mm x 36 mm |

Power Supply

| | |
|------------------------------|---|
| Power Source | Ni-MH rechargeable, Battery Pack, 6.0 VDC, 900 mAh |
| Operating Time | 9 hours Low Power |
| (Transmit: Receive: Standby) | 7 hours High Power |
| (5: 5: 90 ratio) | |

Receiver

| | |
|----------------------------|-----------------------------|
| Useable Sensitivity | >-119 dBm |
| Maximum Audio Output Power | > 0.3 Watt maximum (8 Ohm) |
| Modulation Distortion | < 5% (1 kHz 70%) |

Transmitter

| | |
|-----------------------|---|
| RF Output Power | 3.0 Watt maximum (high power) 1.0 Watt maximum (low power) |
| Maximum Deviation | +/- 2.5 kHz |
| Modulation Distortion | < 5% (1 kHz 70%) |

This transceiver complies with FCC regulations for use in the United States of America. Use in other countries may be prohibited or restricted by local regulation. Please check with the local regulating agency before using this device outside the United States of America.

Weather Channel Frequencies:

| Channel | Freq. MHz | Channel | Freq. MHz |
|---------|-----------|---------|-----------|
| 1 | 162.550 | 6 | 162.500 |
| 2 | 162.400 | 7 | 162.525 |
| 3 | 162.475 | 8* | 161.650 |
| 4 | 162.425 | 9* | 161.775 |
| 5 | 162.450 | 10* | 163.275 |

*Canadian Marine

Main Channel Frequencies:

| Channel | Freq. MHz | Channel | Freq. MHz |
|---------|-----------|---------|-----------|
| 1 | 462.5625 | 9 | 462.6250 |
| 2 | 462.5875 | 10 | 462.6750 |
| 3 | 462.6125 | 11 | 462.5500 |
| 4 | 462.6375 | 12 | 462.6000 |
| 5 | 462.6625 | 13 | 462.6500 |
| 6 | 462.6875 | 14 | 462.7000 |
| 7 | 462.7125 | 15 | 462.7250 |
| 8 | 462.5750 | | |

NOTE: Channels 1 through 7 are shared with FRS radios.

**Continuous Tone Coded Squelch System Tone
Frequencies (in Hz)**

| CTCSS | Freq. Hz | CTCSS | Freq. Hz |
|--------------|-----------------|--------------|-----------------|
| 1 | 67.0 | 20 | 131.8 |
| 2 | 71.9 | 21 | 136.5 |
| 3 | 74.4 | 22 | 141.3 |
| 4 | 77.0 | 23 | 146.2 |
| 5 | 79.7 | 24 | 151.4 |
| 6 | 82.5 | 25 | 156.7 |
| 7 | 85.4 | 26 | 162.2 |
| 8 | 88.5 | 27 | 167.9 |
| 9 | 91.5 | 28 | 173.8 |
| 10 | 94.8 | 29 | 179.9 |
| 11 | 97.4 | 30 | 186.2 |
| 12 | 100.0 | 31 | 192.8 |
| 13 | 103.5 | 32 | 203.5 |
| 14 | 107.2 | 33 | 210.7 |
| 15 | 110.9 | 34 | 218.1 |
| 16 | 114.8 | 35 | 225.7 |
| 17 | 118.8 | 36 | 233.6 |
| 18 | 123.0 | 37 | 241.8 |
| 19 | 127.3 | 38 | 250.3 |

* oF = No Tone

90 DAY LIMITED WARRANTY

Applies to Audiovox Family Radio and General Mobile Service Products.

AUDIOVOX CORPORATION (the Company) warrants to the original retail purchaser of this product that should this product or any part thereof, under normal use and conditions, be proven defective in material or workmanship within 90 days from the date of original purchase, such defect(s) will be repaired or replaced with new or reconditioned product (at the Company's option) without charge for parts and repair labor.

To obtain repair or replacement within the terms of this Warranty, the product is to be delivered with proof of warranty coverage (e.g. dated bill of sale), specification of defect(s), transportation prepaid, to the warranty center at the address shown below.

The Company disclaims liability for communications range of this product.

This Warranty does not apply to any product or part thereof which, in the opinion of the Company, has suffered or been damaged through alteration, improper installation, mishandling, misuse, neglect, accident, or by removal or defacement of the factory serial number/bar code label(s). THE EXTENT OF THE COMPANY'S LIABILITY UNDER THIS WARRANTY IS LIMITED TO THE REPAIR OR REPLACEMENT PROVIDED ABOVE AND, IN NO EVENT, SHALL THE COMPANY'S LIABILITY EXCEED THE PURCHASE PRICE PAID BY PURCHASER FOR THE PRODUCT.

This Warranty is in lieu of all other express warranties or liabilities. ANY IMPLIED WARRANTIES, INCLUDING ANY IMPLIED WARRANTY OF MERCHANTABILITY, SHALL BE LIMITED TO THE DURATION OF THIS WRITTEN WARRANTY. ANY ACTION FOR BREACH OF ANY WARRANTY HEREUNDER INCLUDING ANY IMPLIED WARRANTY OF MERCHANTABILITY MUST BE BROUGHT WITHIN A PERIOD OF 30 MONTHS FROM DATE OF ORIGINAL PURCHASE. IN NO CASE SHALL THE COMPANY BE LIABLE FOR ANY CONSEQUENTIAL OR INCIDENTAL DAMAGES FOR BREACH OF THIS OR ANY OTHER WARRANTY, EXPRESS OR IMPLIED, WHATSOEVER. No person or representative is authorized to assume for the Company any liability other than expressed herein in connection with the sale of this product.

Some states do not allow limitations on how long an implied warranty lasts or the exclusion or limitation of incidental or consequential damage so the above limitations or exclusions may not apply to you. This Warranty gives you specific legal rights and you may also have other rights which vary from state to state.

AUDIOVOX CORPORATION, 150 MARCUS BLVD., HAUPPAUGE, NEW YORK 11788
1-800-290-6650 128-5385A

PRINTED IN CHINA

128-6294